

novofine® Autocover® 30G

Disposable Safety Needle

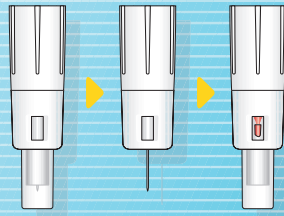

novofine® Autocover® 30G

Disposable Safety Needle
30 gauge x 1/3" (8 mm)
Sterile, Non-toxic, Non-pyrogenic, Single use

CAUTION: Keep hands away from the needle shield at all times.

Designed and recommended for use with Novo Nordisk insulin delivery devices.

Introduction

NovoFine® Autocover® is a single use injection needle with an automatic safety lock that is designed to reduce needle stick injuries.

The safety lock indicates that the needle has been used. If the safety lock indicator is red, the needle cannot be used.

The plastic shield on NovoFine® Autocover® may help reduce needle anxiety by hiding the needle from view.

NovoFine® Autocover® is not recommended for the blind or visually impaired without the assistance of a sighted individual trained to use it.

Please read these instructions before using NovoFine® Autocover®.

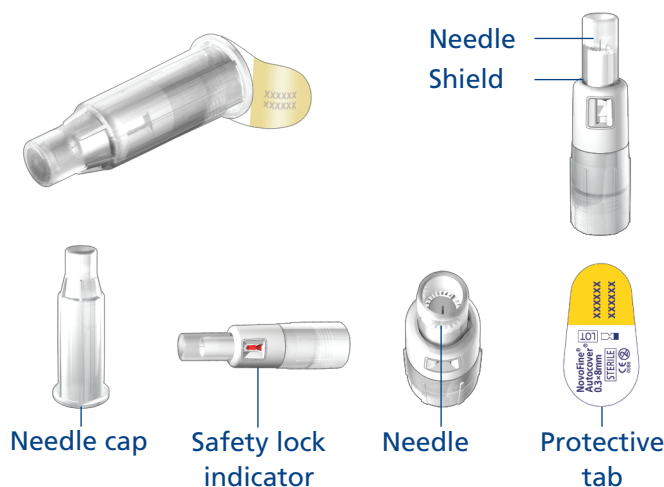

1 Attaching NovoFine® Autocover®

Take the protective tab off the NovoFine® Autocover® needle. With the needle tip pointing away from you, attach the needle tightly onto the delivery device.

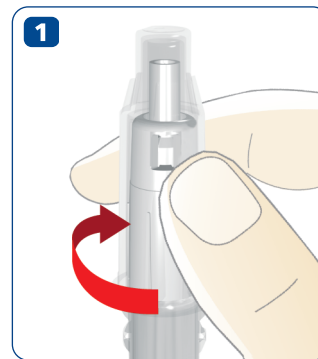

2 Removing the Needle Cap

Pull off the needle cap.



3 Checking the Flow (air shot)

Always check the flow in the delivery device before each injection by performing an air shot. Follow the procedure described in the delivery device instruction leaflet.

A drop of liquid should appear at the needle tip; if not, repeat until liquid appears at the needle tip. Please note that the drop of liquid may fall back into the needle shield. If after repeating and still no liquid appears at the needle tip, refer to instructions for function check.

⚠ Before injecting, make sure that the needle is not locked. If the safety lock indicator is red, the needle cannot be used. Remove the needle, and attach a new needle.



4 Making the Injection

- Select the dose prescribed by your health care professional.
- Push the needle shield against taut skin (at a 90° angle) following the injection technique demonstrated by your health care professional. The needle shield will retract and allow the needle to penetrate the skin. To ensure a more firm surface at the injection site, you may also pinch up the skin to create a skinfold.
- Inject your dose following the procedure described in the delivery device instruction leaflet.
- Hold needle in place for at least 6 seconds or as directed by your health care professional.
- Withdraw the needle from the skin.

A few droplets of insulin may appear on the skin (wipe away with damp cloth). This is insulin collected in the needle shield during the air shot. It has no effect on the dose delivered.

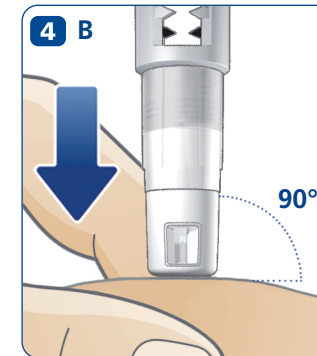
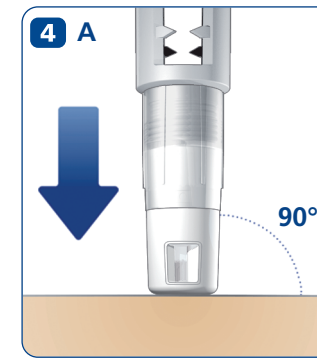

5 Safety Lock

The safety mechanism will be activated automatically when the needle is withdrawn from the skin.

The red indicator tells you that the safety lock has been activated. If the red indicator does not appear, the safety lock has not been engaged, and a needle stick injury may still occur. Carefully discard needle as described in step 6. Do not reinject. Call your health care professional or call 1-800-727-6500.

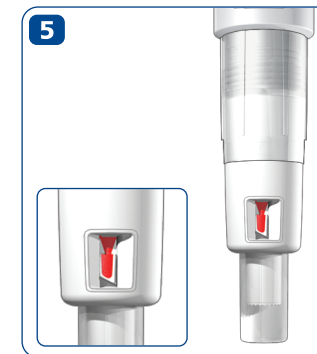

6 Removing the Needle

After the injection, remove the needle without replacing the needle cap. Dispose of the used needle carefully in accordance with all local regulations.

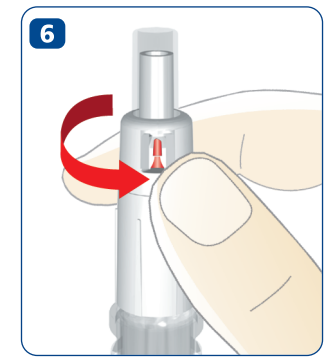

7 Function Check

If you think that your insulin delivery device is not working properly, and the delivery device instruction leaflet recommends a function check, please follow the procedure described below:

- Attach a new NovoFine® Autocover® needle onto the delivery device.
- Check the flow by performing an air shot as described in Section 3 and the delivery device instruction leaflet.
- Dispense 20 units into the needle cap, holding the device with the needle pointing downwards.

The insulin should fill the lower part of the needle cap (see illustration). If the pen has released too much or too little insulin, repeat the test. If it happens again, do not use the delivery device. Please refer to your device leaflet for any further instructions.



Date of issue: August 2007
Version 3
U.S. Patent Nos. 6,547,764, 6,855,129 and other patents pending.
© 2005/2007 Novo Nordisk Inc.
For information contact:
Novo Nordisk Inc.
Princeton, NJ 08540
1-800-727-6500
www.novonordisk-us.com
Manufactured by:
Novo Nordisk A/S
2880 Bagsvaerd, Denmark

